

迷失異空

人類所產生的污染日漸增多，各國政府為逃避處理費用將大部分垃圾發射往太空。

人類與外星人在宇宙探索之間，被垃圾環流牽扯，發現原來夜空閃閃發光的星辰是人類每日產生的廢物。



心智圖

迷失異空--宇宙流浪

靈感來源：環境污染+太空未來

設計理念：

天空閃閃發光的星辰，墜落下的流星不過是人類自己作下的孽罷了。

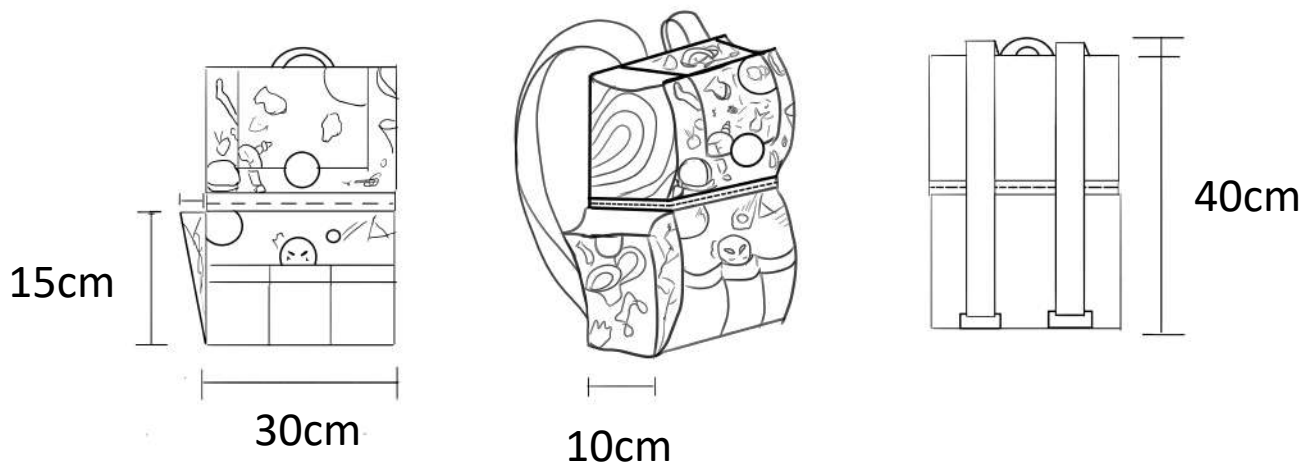

PU人造皮革

迷失異空--迴夢傾頹

靈感來源：太空探索，ASCII密碼

設計理念：闖入垃圾環流之中，驚覺太空人在其中悠然自得。

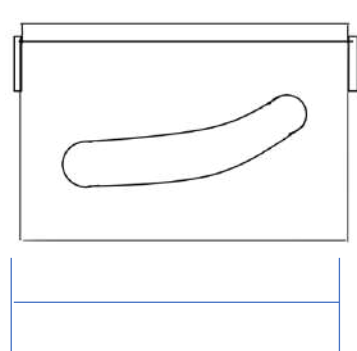
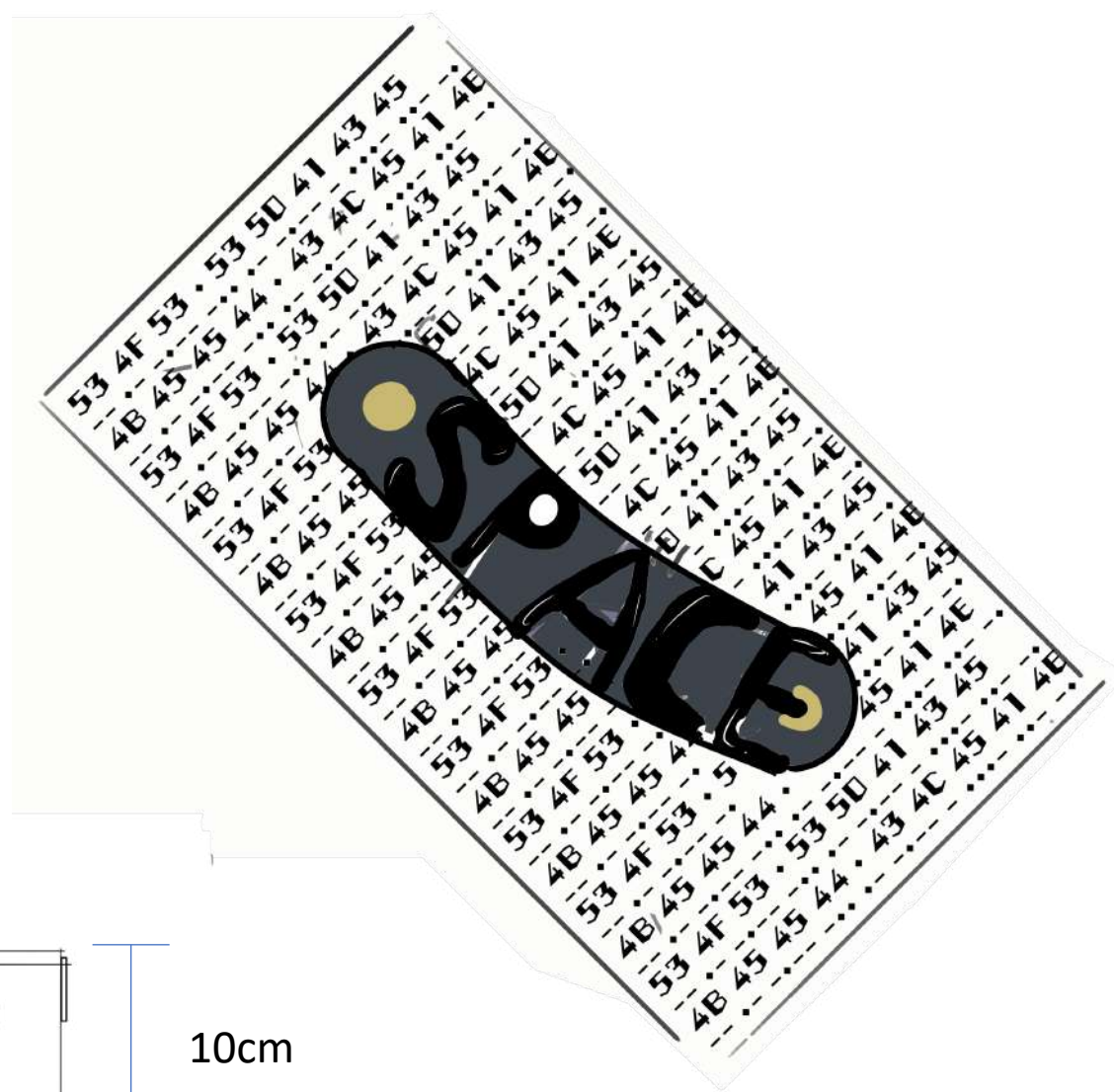

15cm



2cm

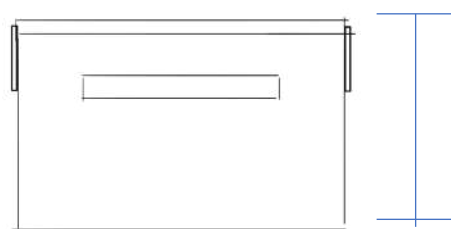

10cm

十字紋牛皮



PU人造皮革

迷失異空

靈感來源：太空探索，ASCII密碼，摩斯密碼

設計理念：發現無法脫離環流牽引，遂發出求救，奈何受垃圾干擾，始終無法傳遞完整訊息。

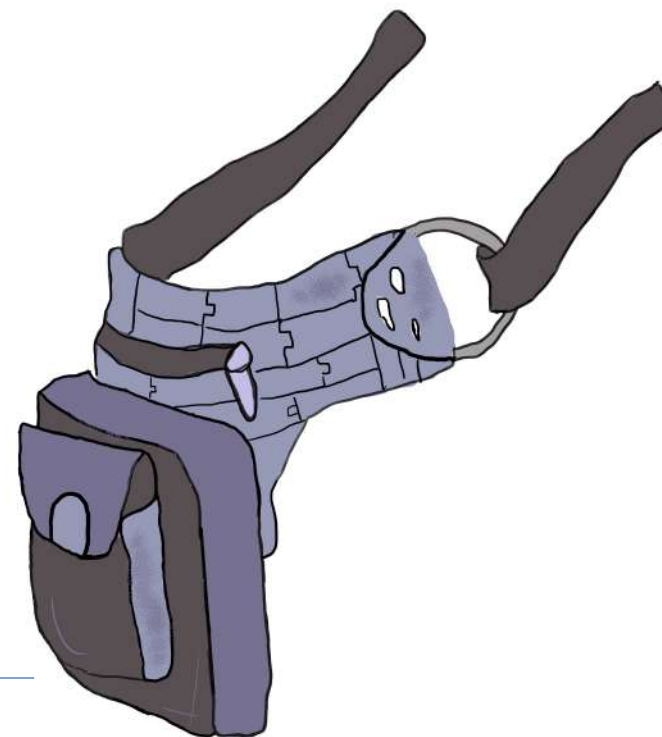
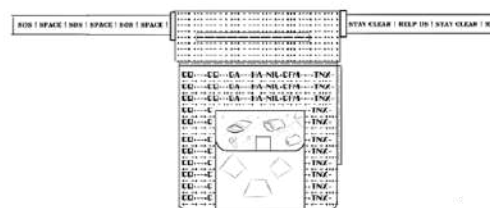
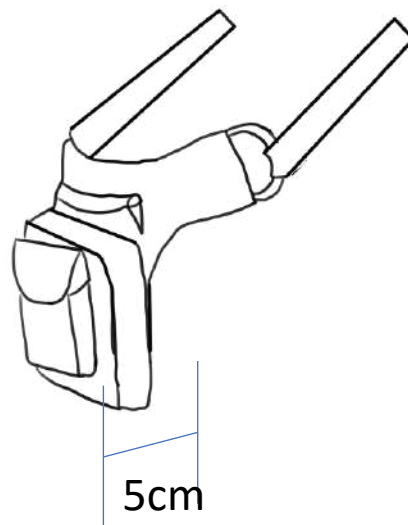
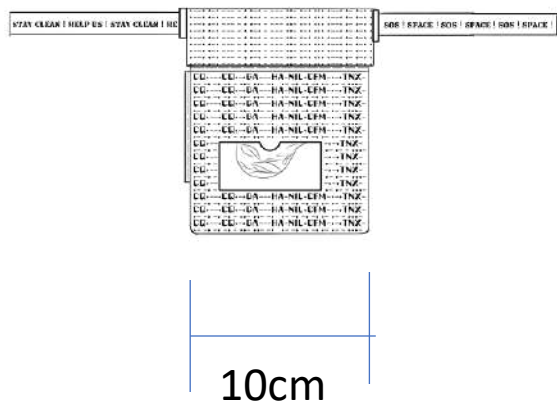

PU人造皮革

參賽設計圖（共九款）

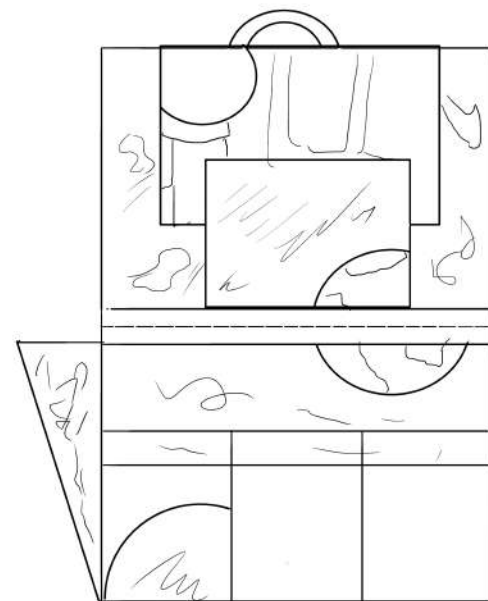

參賽設計圖 (共九款)

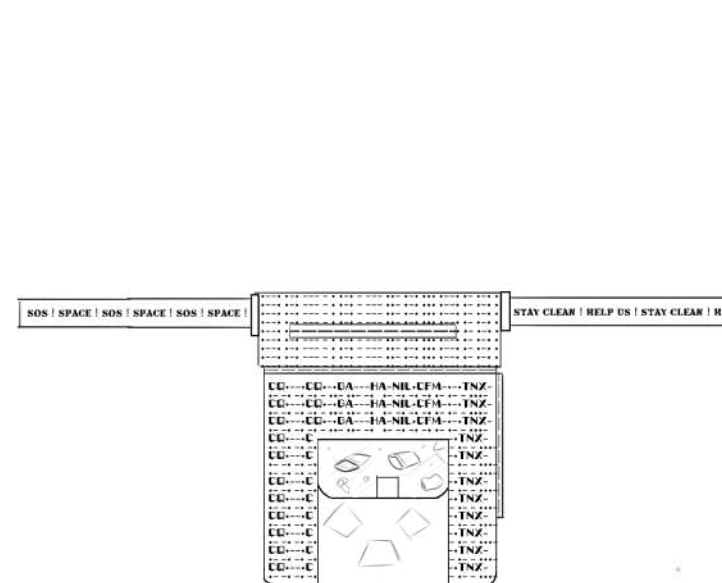
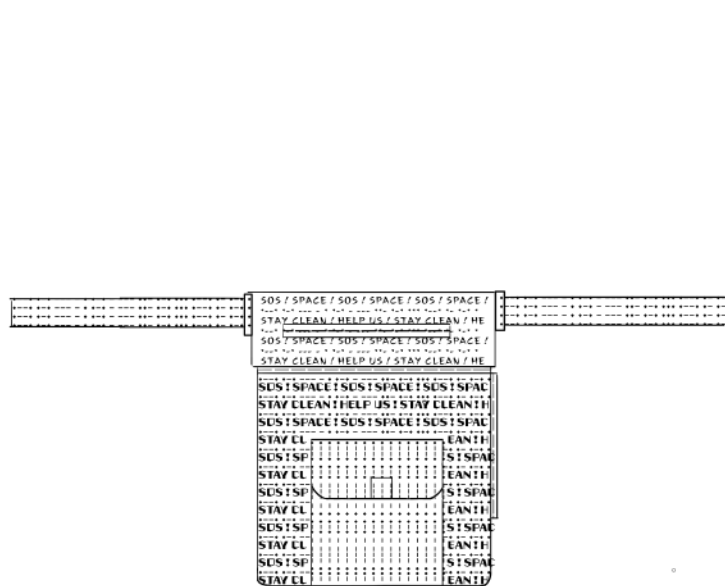
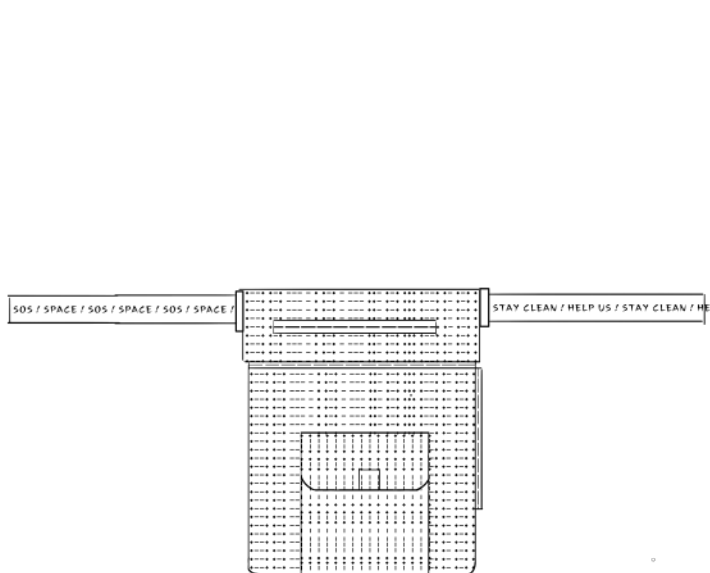

二十七種配色圖

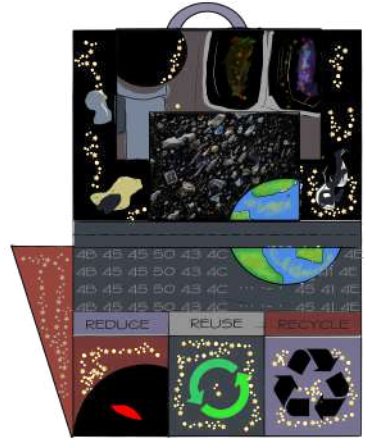
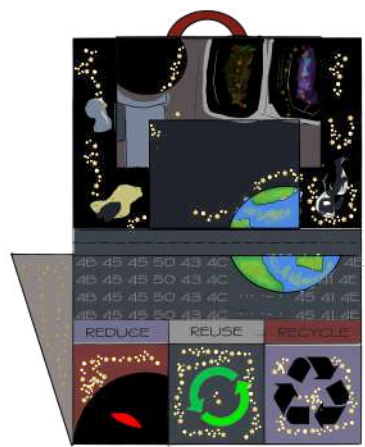
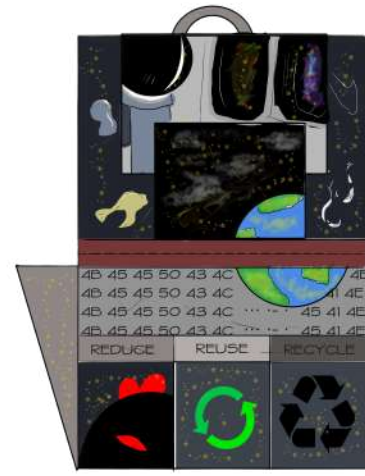
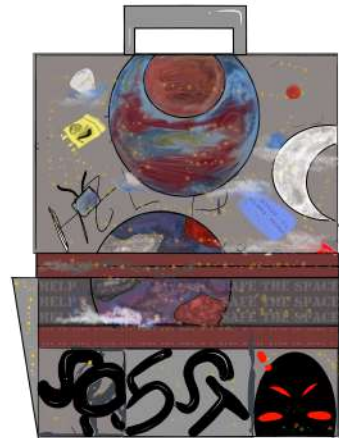
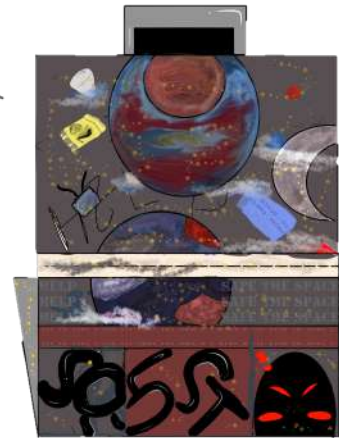
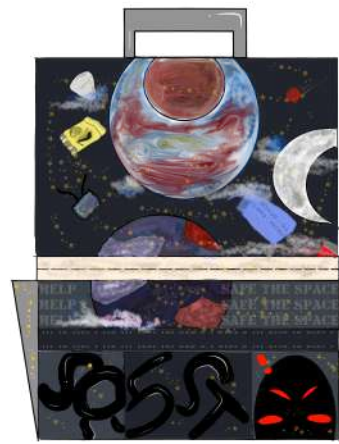
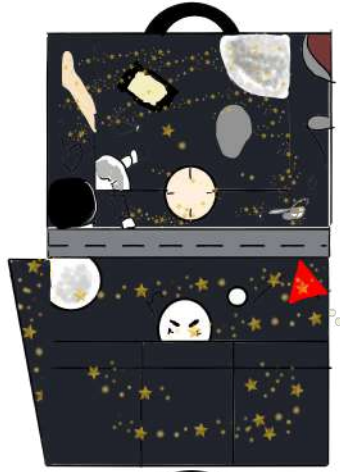

二十七種配色圖

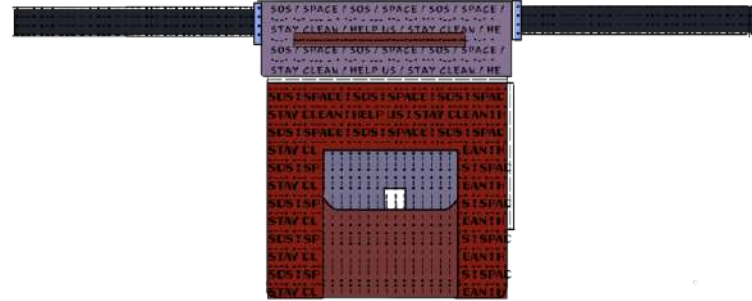
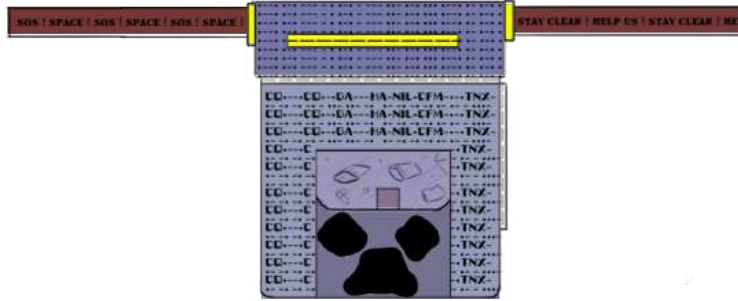
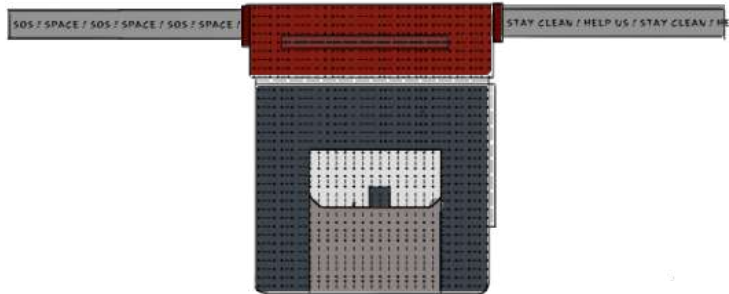
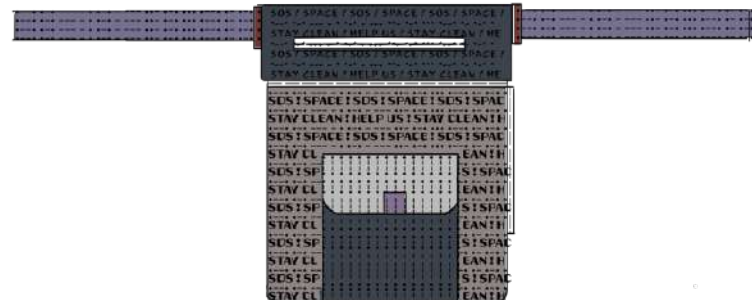
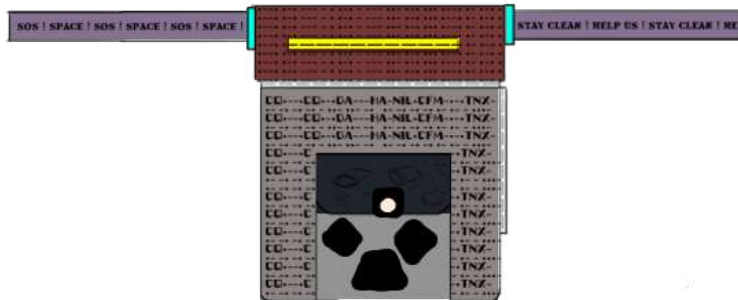
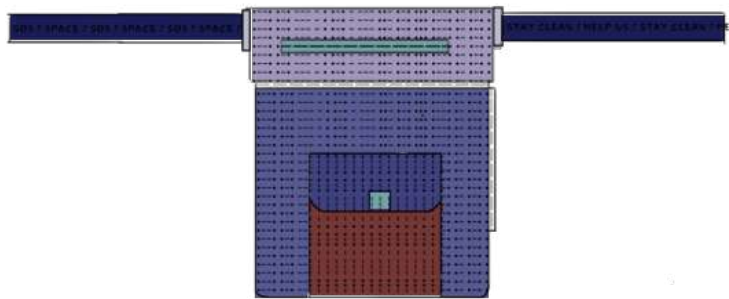
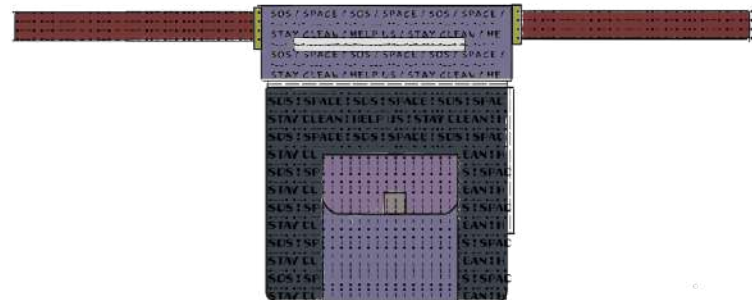
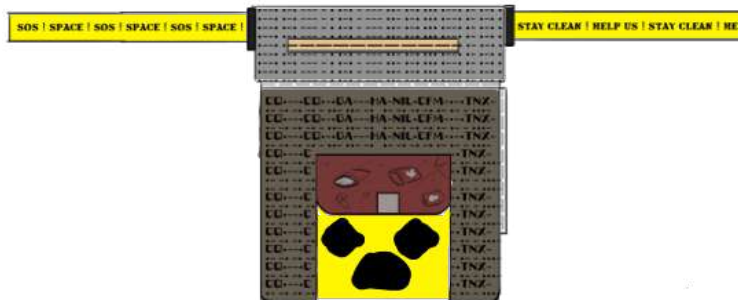
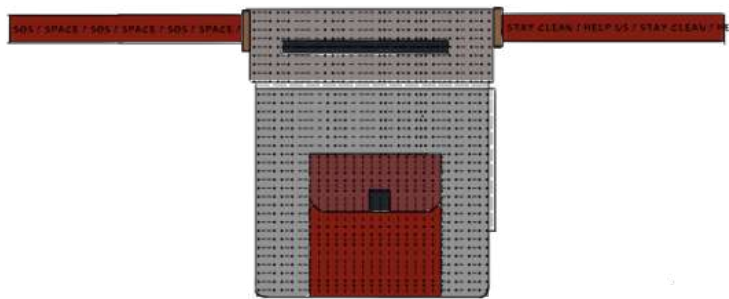

二十七種配色圖

